



3 year guarantee - Made in France

Specific information

MOBILE PARTNER

(EN) Pulley
(FR) Poulie
(DE) Seilrolle
(IT) Carrucola
(ES) Polea

MOBILE

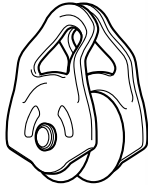

75 g



7 ≤ Ø ≤ 13 mm

PARTNER



56 g

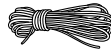

7 ≤ Ø ≤ 11 mm

UIAA

CE 0082 EN 12278

individually tested

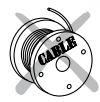

P525010B (080410) recto

Tracability and Markings

MOBILE / PARTNER

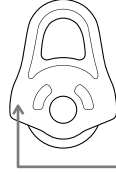

CE 0082

a. Body controlling the manufacture of this PPE | b. Notified body that carried out the CE type inspection

APAVE SUD Europe BP 193,
13322 Marseille Cedex 16
N°0082

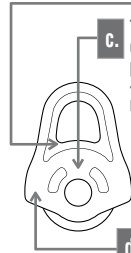

c. Traceability: datamatrix = product reference + individual number

d. Rope diameter

e. Individual number

00 000 A 0000

f. Year of manufacture

g. Day of manufacture

h. Control or name of inspector

i. Incrementation

1. Field of application

2. Nomenclature of parts

MOBILE

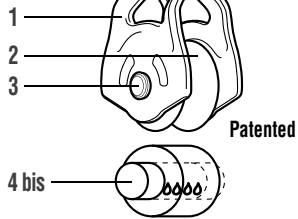

PARTNER

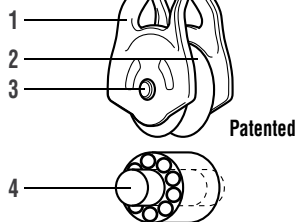

3. Inspection, points to verify

4. Compatibility

5. Values

5A. Working load limit
Valeur d'utilisation maxi
Maximale Gebrauchslast
Valore d'utilizzo massimo
Valor de utilización máximo

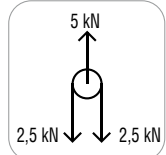
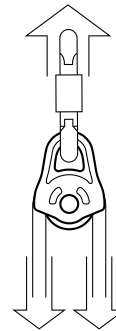

OK!

5B. Breaking load
Charge de rupture
Bruchlast
Carico di rottura
Carga de rotura

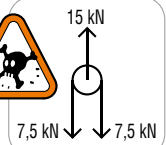
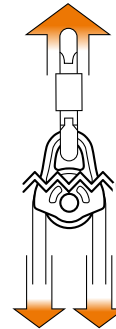

6. Pulley system efficiency

6A. Simple pulley system

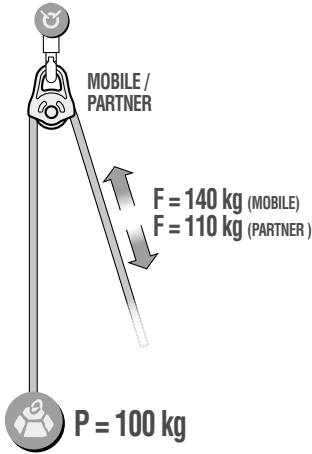

with progress capture

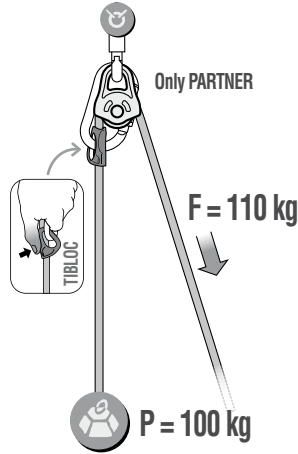

6B. 2:1 hauling system

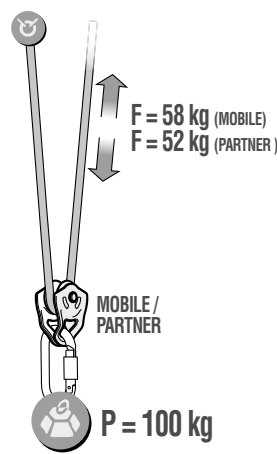

6C. 3:1 hauling system with progress capture

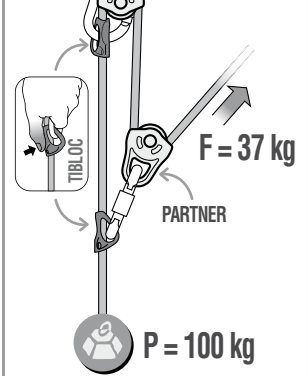

	MOBILE	PARTNER		MOBILE	PARTNER	
Theoretical force	$F = P$	$F = P$		$F = 0,5 P$	$F = 0,5 P$	$F = 0,33 P$
	$F = 1,4 P$	$F = 1,1 P$		$F = 0,58 P$	$F = 0,52 P$	$F = 0,37 P$
	$F = 2 P$	$F = 2 P$		$F = 0,66 P$	$F = 0,66 P$	$F = 0,57 P$

7. Progress capture systems



Occasional use
Utilisation occasionnelle
Zur Aushilfe
Utilizzo occasionale
Utilización ocasional

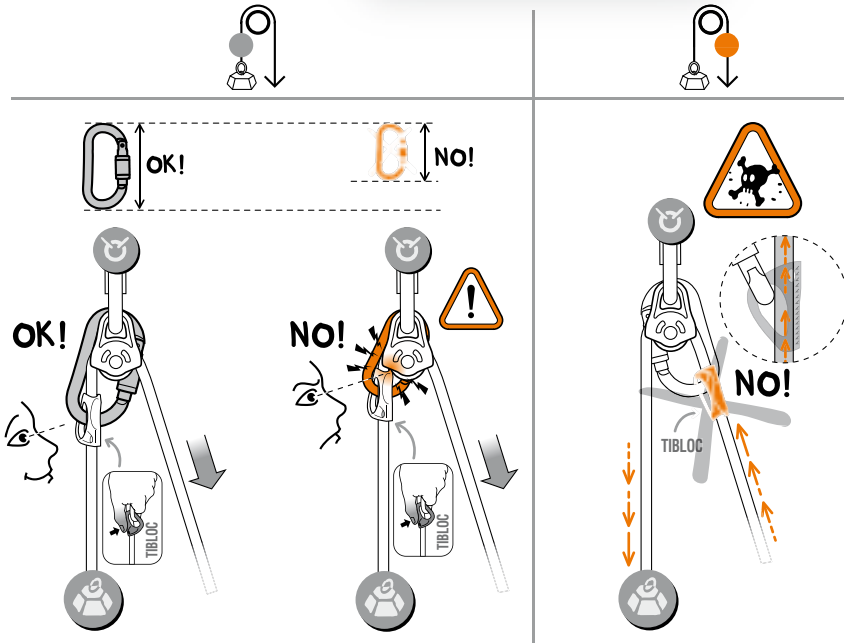

8. Positioning and redirection

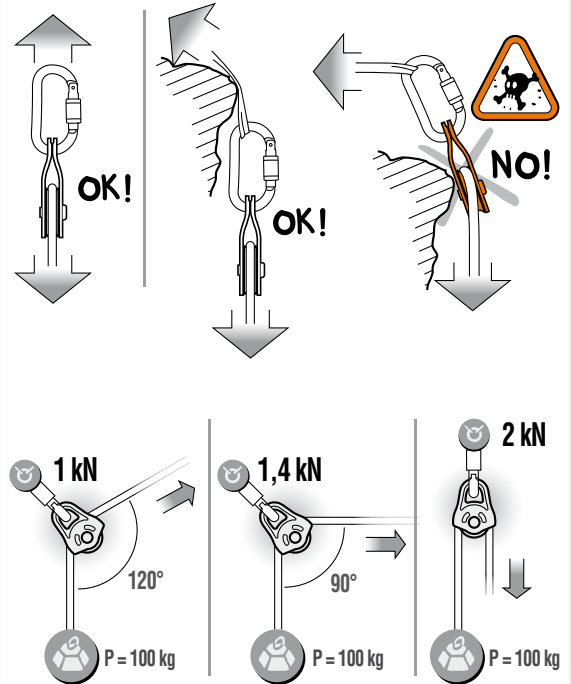

	<p>(EN) Temperature (FR) Température (DE) Temperatur (IT) Temperatura (ES) Temperatura (PT) Temperatura (NL) Temperatuur (SE) Temperatur (FI) Lämpötila (NO) Temperatur</p>	<p>(RU) Температура (CZ) Teplota (PL) Temperatura (SI) Temperatura (HU) Hőmérséklet (BG) Температура (JP) 気温 (CN) 温度 (TH) อุณหภูมิ</p>			<p>(EN) Maintenance (FR) Entretien (DE) Wartung (IT) Manutenzione (ES) Mantenimiento (PT) Manutenção (NL) Onderhoud (SE) Underhåll (FI) Huolehtiminen (NO) Vedlikehold</p>	<p>(RU) Техническое обслуживание (CZ) Údržba (PL) Konserwacja (SI) Vzdrževanje (HU) Karbantartás (BG) Поддръжане (JP) メンテナンス (KR) 保养 (CN) 保养 (TH) การซ่อมแซม</p>
	<p>(EN) Storage and transport (FR) Rangement et transport (DE) Lagerung und Transport (IT) Sistemazione e trasporto (ES) Almacenamiento y transporte (PT) Armazenamento e transporte (NL) Opbergen en vervoeren (FI) Säilytys ja kuljetus (NO) Lagring og transport (RU) Хранение и транспортировка (CZ) Skladování a doprava</p>	<p>(PL) Pakowanie i transport (SI) Shranjevanje in transport (HU) Tárolás, szállítás (BG) Транспорт и съхранение (JP) 持ち運びと保管方法 (KR) 보관과 운송 (CN) 运输及储存 (TH) การขนส่งและกการเก็บรักษา</p>	<p>(EN) Cleaning Disinfection (FR) Nettoyage Désinfection (DE) Reinigung Desinfektion (IT) Pulizia Disinfezione (ES) Limpieza Desinfección (PT) Limpeza Desinfecção (NL) Reiniging Ontsmetting (SE) Rengöring Desinficering (FI) Puhdistus Desinfiointi (NO) Rengjøring Desinfisering (RU) Чистка Дезинфекция</p>	<p>(CZ) Čištění Desinfekce (PL) Czyszczenie Dezynfekcja (SI) Čiščenje/razkuževanje (HU) Tisztítás (BG) Почистване Дезинфекция (JP) 手入れ方法 消毒 (KR) 清洗 消毒 (CN) 清洗 消毒 (TH) ทำความสะอาดโดย ใช้สารฆ่าเชื้อ</p>		
	<p>(EN) Drying (FR) Séchage (DE) Trocknen (IT) Asciugamento (ES) Secado (PT) Secagem (NL) Het drogen</p>	<p>(SE) Torkning (FI) Kuivaus (NO) Torking (RU) Сушка (CZ) Sušení (PL) Suszenie (SI) Sušenje</p>	<p>(HU) Szárítás (BG) Сушене (JP) 乾燥 (CN) 使干燥 (TH) ทำให้งแห้ง</p>	<p>(EN) Dangerous products (FR) Produits dangereux (DE) Gefährliche Produkte (IT) Prodotti pericolosi (ES) Productos peligrosos (PT) produtos perigosos (NL) Gevaarlijke producten (SE) Farliga produkter (FI) Vaaralliset tuotteet (NO) Farlige produkter (RU) Опасная продукция</p>	<p>(CZ) Nebezpečné výrobky (PL) Produkty niebezpieczne (SI) Nevarne kemikalije (HU) Veszélyes termékek (BG) Опасни продукти (JP) 有害物質 (KR) 危險產品 (CN) 危險產品 (TH) วัตถุอันตราย</p>	

Legends

	<p>(EN) Anchor (FR) Amarrage (DE) Anschlagpunkt (IT) Ancoraggio (ES) Anclaje (PT) Amarração (NL) Verankering (SE) Förankring (FI) Ankkuri (NO) Forankring</p>	<p>(RU) Точка страховки (CZ) Ukotvení (PL) Punkt stanowiskowy (SI) Sidrišče (HU) Fix pont (BG) Закрепване (JP) 支点 (KR) 확보점 (CN) 确定点</p>	<p>(TH) สุ่ม</p>
--	---	---	------------------

PETZL
ZI Cidex 105A
38920 Crolles
France
www.petzl.com/contact

ISO 9001
Copyright Petzl